

ABLOY® PADLOCKS – UNSURPASSED PERFORMANCE



The right materials, design and production methods make **ABLOY®** Padlocks the only choice in harsh conditions.

Better Than Ever

ABLOY[®] padlocks have been the market leaders for decades. Independent test results have confirmed that **ABLOY**[®] padlocks continue to operate smoothly after the toughest corrosion tests. They are therefore recommended as the best possible choice for unprotected use in severe conditions. Durable materials such as hardened boron steel provide effective protection against drilling, sawing, cutting, twisting or shimming.

ABLOY[®] PL362 is the strongest padlock on the market. It is a product that has passed the most demanding Scandinavian break-in tests and is classed as Scandinavian Grade 5, the highest grade. The unique locking construction makes it extremely difficult to attack.

All grades of **ABLOY**[®] padlocks employ similar technical solutions to provide superior performance in a wide range of security applications.





ABLOY® padlocks offer a selection of different key systems, key profiles and key security levels.



ABLOY® – Unique features and benefits

Excellent resistance against physical attack

The hardened steel housings and hardened boron steel shackles in **ABLOY®** padlocks provide maximum resistance against physical attack. The hardened, free-spinning protection plate prevents drill bits from penetrating the lock. Further security is provided by hardened stainless ball bearings locking the shackle at both ends. The highest security can be provided by non-rekeyable construction.

The unique cylinder mechanism offers superior master-keying features

The unique **ABLOY®** rotating detainer disc cylinder mechanism offers extensive master-keying possibilities due to the several million different key combinations available. All **ABLOY®** cylinder products from door locks, camlocks and furniture locks to padlocks can be made to operate with just one key.

A model for every purpose

The selection of body sizes, shackle diameters and materials in the **ABLOY®** padlock range means that it is easy to choose exactly the right product for each application.

Maximum resistance against corrosion

The unique surface treatments used by **ABLOY®** guarantee that the corrosion resistance of both the visible parts of each lock and the internal parts is at the highest possible level. **ABLOY®** padlocks are recommended as the best products for the naval environments and coastal locations.

Reliable function in all conditions

ABLOY® padlocks are widely used by governments, utility and national transportation organisations as all the component parts are highly-resistant to wear, dirt, moisture, corrosion and freezing. **ABLOY®** padlocks do not contain springs or parts which could jam.

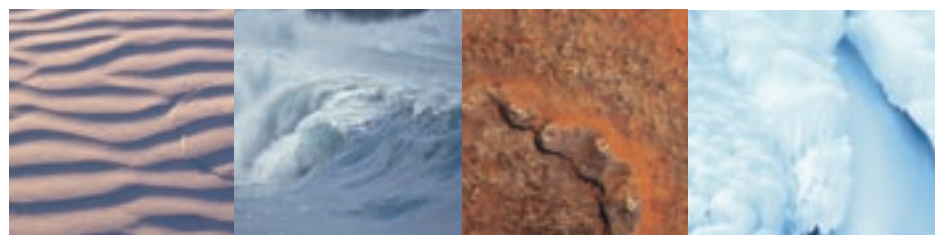



ABLOY® PADLOCKS – for applications that demand perfection

Decades of experience set by our clients' requirements within various applications, have resulted in today's extensive range of ABLOY® padlocks. Our range of security solutions continue to offer a level of performance and protection which remains unsurpassed.



PL362

STEEL PADLOCK WITH RAISED SHOULDERS

Grade 6



For applications where maximum security is required. Case-hardened steel body with raised shoulders and a top-loaded cylinder provide the highest level of security and protection. Applications include containers, train wagons, trucks, lorries, heavy sliding doors, military applications etc.

PL362 is equipped with a case hardened boron steel shackle, diameter 15 mm.

PL350, PL350/50

STEEL PADLOCK

Grade 5

Case-hardened steel body provides tough protection for high security applications, including: containers, train wagons, trucks, lorries, warehouses etc. Equipped with case hardened boron steel shackle, diameter 14 mm.



PL342

STEEL PADLOCK WITH RAISED SHOULDERS

Grade 4



By extending the case-hardened steel body to surround the shackle we have made this padlock virtually impregnable against attack by cutting and prying tools. Suitable for heavy sliding doors, train wagons, trucks, warehouses etc.

PL342 is equipped with case hardened boron steel shackle, diameter 10 mm.

PL340, PL340/50

STEEL PADLOCK

Grade 4

Extra-strong padlocks for applications where high security is required. Ideal for construction equipment, tractor trailers and remote storage areas, trucks, storage bins, roller-shutter doors, motorcycles and warehouses.

The case-hardened steel body is highly resistant to all types of physical attack.

Equipped with hardened boron steel shackle, diameter 10 mm.



PL341, PL341 /50

BRASS PADLOCK

Grade 3



A strong padlock for storage doors, gates and windows as well as trailers, protective bars, storage lockers, boats, roller-shutter doors etc.

Equipped with hardened boron steel shackle, diameter 10 mm.

PL330, PL330/50 Grade 3

BRASS PADLOCK

PL330/100

An all-purpose padlock of durable construction for storage doors, motorcycles, gates, trailers, power station switches etc.

Equipped with hardened boron steel shackle, diameter 8 mm.

Also available with non-sparking brass or stainless steel shackle (security grading not tested).

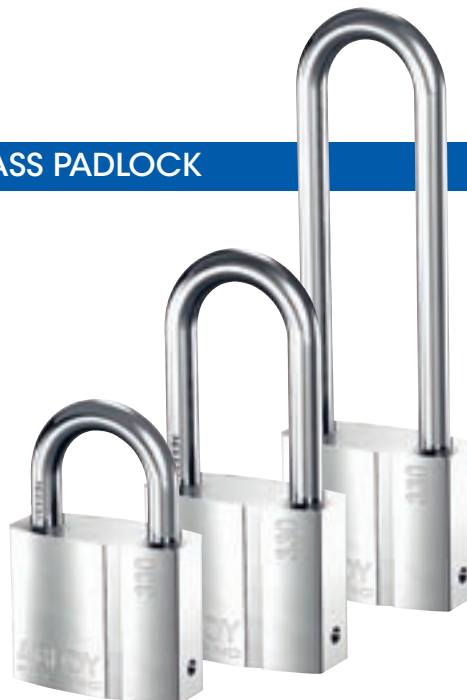

PL321/20, PL321/50

BRASS PADLOCK



An all-purpose padlock of durable construction for storage doors, gates, trailers, power station switches etc. Equipped with stainless steel shackle, diameter 5 mm.

PL320/20 Grade 2

BRASS PADLOCK

PL320/50



A multi-purpose padlock ideal for cash boxes, tool boxes, storage cabins, light machinery and lockers.



3020 Grade 2

BRASS PADLOCK

3021



This general purpose padlock has a die-cast, compact brass body and is furnished with raised shoulders which provide added strength and shackle clearance. A cost-effective product for securing boats, bicycles, power station switches, tool boxes and storage sheds. Shackle diameter 7 mm.



PL318



DIE-CASTED ZINC PADLOCK

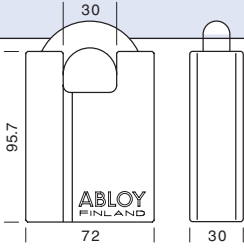
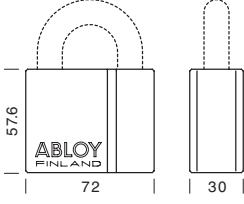
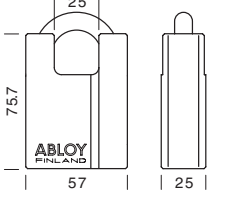
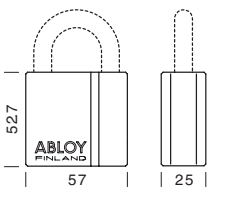
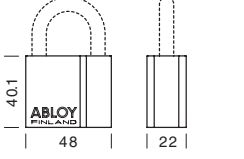
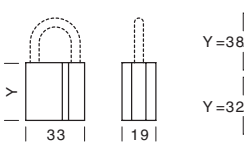
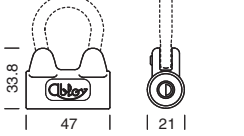
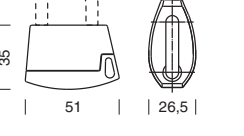

A multi-purpose padlock with 6,5 mm chrome plated steel shackle and die-casted lock body with coloured plastic cover. The options of colour for plastic cover are dark blue/light blue, green/violet and yellow/black. Cost effective product preferably for indoor use eg. cabinets and tool boxes.

MODEL		BODY		BODY		
	NUMBER	GRADE	MATERIAL	FINISH	MATERIAL	FINISH
	PL362	6	CHS	chrome	CHBS	chrome
	PL350 PL350/50	5 5	CHS	chrome	CHBS	chrome
	PL342	4	CHS	chrome	CHBS	chrome
	PL340 PL340/50 PL341 PL341/50	4 4 3 3	CHS brass	chrome	CHBS	chrome
	PL330 PL330/50 PL330/100	3 3 *)	brass	chrome	CHBS (brass, stainless steel*)	chrome
	PL321/20 PL321/50 PL320/20 PL320/50	*) *) 2 *)	brass	chrome	stainless steel	chrome
	3020 3021	2 *)	brass	brass	CHS	chrome
	PL318	*)	die-casted zinc with plastic cover		steel	chrome

*) = not tested CHS = case-hardened steel CHBS = case-hardened boron steel

SHACKLE						KEYING					CYLINDER OPTIONS		
						NUMBER OF DISCS	REKEY-ABLE	NON REKEY-ABLE	KEY REMOVABLE		ABLOY® CLASSIC KEY	ABLOY® EXEC KEY	ABLOY® PROTEC KEY
mm	inches	mm	inches	mm	inches				IN LOCKED POSITION	BOTH IN LOCKED AND UNLOCKED POSITION			
15	19/32	25	63/64	30	1 11/64	11	●	●	●		●	●	●
14	35/64	25	63/64	31	1 7/32	11	●	●	●		●	●	●
14	35/64	50	1 31/32	31	1 7/32	11	●	●	●		●	●	●
10	25/64	25	63/64	25	63/64	11	●	●	●		●	●	●
10	25/64	25	63/64	28	1 3/32	11	●	●	●		●	●	●
10	25/64	50	1 31/32	28	1 3/32	11	●	●	●		●	●	●
10	25/64	25	63/64	28	1 3/32	11	●	●	●		●	●	●
10	25/64	50	1 31/32	28	1 3/32	11	●	●	●		●	●	●
8	5/16	25	63/64	25	63/64	11	●	●	●		●	●	●
8	5/16	50	1 31/32	25	63/64	11	●	●	●		●	●	●
8	5/16	100	3 30/32	25	63/64	11	●	●	●		●	●	●
5	13/64	20	15/32	18	45/64	11		●	●		●	●	●
5	13/64	50	1 31/32	18	45/64	11		●	●		●	●	●
5	13/64	20	15/32	18	45/64	9		●	●		●	●	●
5	13/64	50	1 31/32	18	45/64	9		●	●		●	●	●
7	9/32	35	1 3/8	26	1 1/32	11		●			●		
7	9/32	76	3	33	1 5/16	11		●			●		
6,5	8/32	20	25/32	21	1/2	9		●			●		

LOCKING PLATES **PL200, PL202, PL201, PL203, PL204**



PL200, PL202

- 12 mm shackle hole
- Grade 3
- PL200 for right-handed doors
- PL202 for left-handed doors
- For frame fixing
- Zinc-plated, polyester-coated case-hardened steel
- Fixing screws included

PL201, PL203

- 18 mm shackle hole
- Grade 4
- PL201 for right-handed doors
- PL203 for left-handed doors
- For frame fixing
- Zinc-plated, polyester-coated case-hardened steel
- Fixing screws included

PL204

- 12 mm shackle hole
- Non-handed
- For frame fixing
- Zinc-plated, polyester-coated case-hardened steel
- Fixing screws included

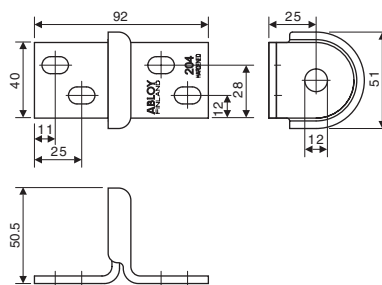
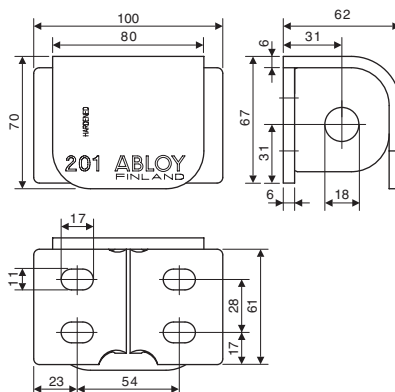
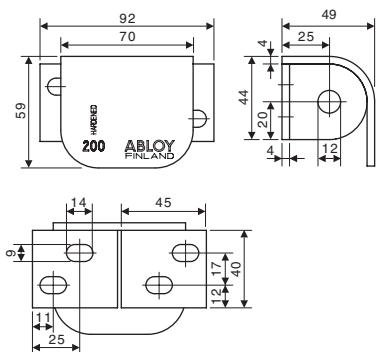

COVERS **802897, 805649, 802858, 808248**

Different plastic covers are available to provide additional protection against dust and impact.

- 802897 and 808248 to suit PL330
- 805649 to suit PL340 and PL341
- 802858 to suit PL350



Attachment chain (length 220 mm) makes it easier to ensure that a padlock does not get mislaid while the object that it secures is open. These chains must not be used as part of a security installation.

Chains are available in two sizes, 805349 for a 8 mm shackle and 805351 for a 10 mm shackle. 810270 for a 14 mm shackle.

ABLOY® padlocks have been designed and manufactured to not only meet the requirements of the EN12320 padlock standard, but exceed as the requirements of our own tests are significantly higher.

ABLOY® padlocks continued to operate smoothly throughout exhaustive

durability tests such as the acetic acid salt-spray test – they are therefore the best possible alternative for use in unprotected locations where the environmental conditions are severe.

Abloy Oy has paid particular attention in design of environmentally-friendly production methods.

As a result we use the most modern and environmentally-friendly surface plating facility in Finland.

All the operations are qualified with the ISO9001 and ISO14001 certifications.

SECURITY GRADES ACCORDING TO THE EN12320 PADLOCK STANDARD

Requirements	1	2	3	4	5	6	
Minimum number of differs	300	1 000	2 500	5 000	10 000	20 000	
Pulling of shackle/staple	3	5	15	30	70	100	kN
Twisting of shackle/staple	40	100	200	450	1 200	2 500	Nm
Cutting of shackle/staple	6	15	25	35	70	100	kN
Blow on shackle/staple (weight/g x height/mm) Test temperature			1 250 x 800 -20°C	3 050 x 1 000 -20°C	6 550 x 1 400 -40°C	7 150 x 1 500 -40°C	x5 times
Blow on lock body (weight/g x height/mm) Test temperature			1 250 x 800 -20°C	3 050 x 1 000 -20°C	6 550 x 1 400 -40°C	7 150 x 1 500 -40°C	x5 times
Load on cylinder plug or locking mechanism			4	5	10	15	kN
Drilling				2	4	8	min
Sawing				2	4	8	min
Torque resistance of cylinder plug			5	15	20	30	Nm

DO-IT-YOURSELF PACKS

The following models of padlock are available in Do-it-Yourself packs

PL350, PL350/50
 PL342
 PL341, PL341/50
 PL340, PL340/50
 PL330, PL330/50
 PL320, PL320/50,
 3 x PL320
 3020, 3021
 3022 (2 x 3020)
 PL200, PL202, PL204

WHEN ORDERING

Cylinder Types

C	ABLOY® CLASSIC
E	ABLOY® EXEC
N	ABLOY® PROTEC

Type of Assembly

KD	KEYED-DIFFERENTLY
KA	KEYED-ALIKE
MK	MASTER-KEYED
UA	UNASSEMBLED

When ordering, please specify:

- Product code (e.g. PL341C)
- Height of the shackle (20, 25, 50, 100 mm)
- Cylinder type (C, E, N)
- Quantity
- Key profile
- Rekeyable/ non-rekeyable
- Type of assembly (KD, KA, MK, UA)
- Keying (in KA and MK systems)
- Disc specification (in UA deliveries)
- Chain (if needed)

ABLOY® – the sign for security



The quality and environmental systems used by Abloy Oy guarantee that customers can be certain of **ABLOY®** quality in every field. We received our first Quality System Certificate - SFS-EN ISO 9001 - in 1989. Just eight years later, Abloy Oy was one of the first companies in Finland to be granted an SFS-EN-ISO 14001 Environmental System Certificate.

Our products are designed and manufactured not only to provide high levels of security, but also to be reliable, user-friendly and aesthetically pleasing.

ABLOY® is your sign for security.



ABLOY® is a registered trademark of Abloy Oy, one of the leading manufacturers of locks, locking systems and architectural hardware and the world's leading developer of products in the field of electromechanical lock technology.

The unique **ABLOY®** detainer disc cylinder mechanism has several advantages over conventional locking mechanisms. Ever since its invention in 1907, it has been a symbol of high security and superior performance.

Our range consists of electromechanical locks, cam locks, padlocks, office furniture locks, rim locks, lock cases, cylinders for different types of mortice locks, door closers, door automatics and architectural hardware. **ABLOY®** locking solutions for every application are available from our world-wide network of distributors.

Customer-oriented development, combined with our long experience and extensive security expertise, mean that **ABLOY®** security solutions employ the very latest technology to meet your needs.



www.abloy.com

Abloy Oy
Wahlforssinkatu 20
P.O.Box 108
FI-80101 JOENSUU
FINLAND
Tel. +358 20 599 2501
Fax +358 20 599 2209

